

Rinnai

Installation and User Manual

REU - 16 FUA - E

“Infinity 16 i”

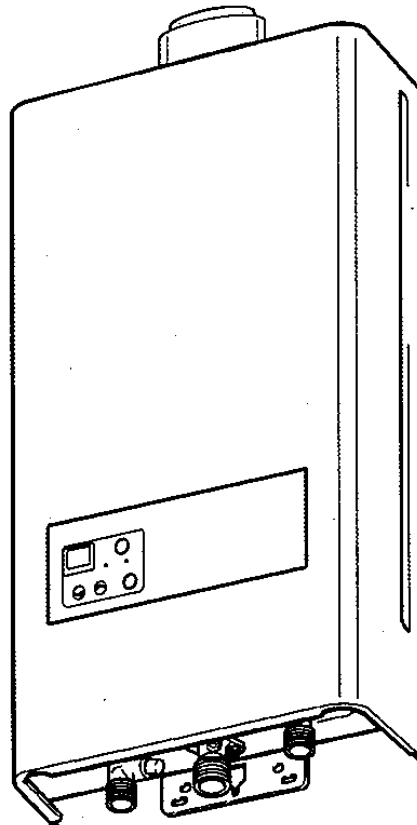

Continuous Flow Water Heater

Important.

Read these instructions carefully before attempting installation or use of this appliance. All work must be carried out by competent persons.

CONTENTS

Contents.....	3
User Instructions.....	4
Features and Benefits.....	5
Important Information.....	6
Operation without Remotes.....	8
Temperature Controls.....	9
Caring for the Infinity.....	15
Error Messages.....	16
Restarting the Rinnai Water Heater.....	18
Installation Instructions.....	19
UK Installation Instructions.....	20
Unpacking Rinnai Water Heater.....	21
Operation Principle.....	22
Main Components.....	23
Installation Instructions.....	25
Flue Requirements.....	30
Temperature Controls.....	34
Testing.....	37
Gas Pressure Setting.....	38
Dip Switch Setting.....	40
Dimensions.....	41
Technical Details.....	42
Flow Chart.....	43
Wiring Diagram.....	44
Diagnostic Points.....	45
Letter of Compliance.....	46
CE Certificate.....	47
Commissioning Checklist.....	48
UK Warranty.....	49
Specification.....	50
Service Contact.....	51

USERS INSTRUCTIONS

The following instructions are designed for the user of the water heater.

The user may not install or adjust the appliance in any way that requires the removal of the front of the unit. To remove the front cover of the unit you must be certified competent to do so. Information for the Installer is given on page 22.

All work done on this appliance must be done by a qualified gas engineer. A qualified gas engineer must carry an up to date CORGI Registered Gas Installer picture identification card while working on gas appliances. If you are unsure do not be afraid to ask the engineer to show you the card. If you are still not satisfied call CORGI on 0870 401 2300 and verify the engineers name with their database. This is for your own safety.

Responsibilities of the USER

The user must abide by all warnings given in this book. The user must only reference the user section of the book, and may not carry out any procedure listed in the installer section.

The user must have the unit checked and maintained annually by a gas engineer.

The user must periodically check the water filter on the inlet to the appliance.

The user must not use the appliance in any way that it was not meant to be used. The user may only use the heater as detailed in the User portion of this manual.

The user must not store or use any flammable vapours or liquids in the vicinity of this or any other appliance.

The user should familiarise themselves with the water heaters gas service valve and the main gas valve to the premises.

IF YOU SMELL GAS

Isolate the gas supply and get out of the building.

Do not try to light any appliance.

Do not turn any light or other electrical switch on or off.

Do not use any telephone in the building.

Call your gas engineer from a safe location and follow their instructions.

If you cannot reach your gas engineer ring the following:

TRANSCO 0800 111 999

FEATURES AND BENEFITS

Congratulations on purchasing the Technologically Advanced, Temperature Controlled, Rinnai Hot Water System.

- The Rinnai **Infinity 16i will NEVER RUN OUT** of hot water. As long as electricity, water, and gas supplies are connected, hot water is available when hot water taps are open.
- Built into the main micro-processor is the facility to **LIMIT THE MAXIMUM TEMPERATURE** of the hot water supplied. The water temperature may be set to various temperatures. This is particularly useful when the hot water unit is installed where young children or the infirm may be using the hot water. If required, the temperature can be changed via the control pad on the front of the unit or with a localised controller. For further information, please contact Rinnai.
- Rinnai Infinity internal units are powered flue appliances. This makes them **COMPACT**, saving both floor and wall space.
- The temperature of outgoing hot water is **CONSTANTLY MONITORED** by a **BUILT-IN SENSOR**. If the temperature of the outgoing hot water rises to more than 55°C the burner is shut OFF and only turned ON again when the temperature falls to below the selected temperature.
- The burner lights automatically when the hot water tap is opened, and extinguishes when the tap is closed. **IGNITION IS ELECTRONIC**, so there is no pilot light. When the hot water tap is off, no gas is used.
- The 16i has a built in controller on the front of the unit for easy control. Two additional external temperature controllers can be mounted remotely from the heater. This offers the following additional features:
 - Localised temperature setting.
 - Diagnostic message.
 - Error Codes.
- Temperatures selected at the controllers are retained in the **SYSTEM MEMORY** when the controller gives up priority or the system is turned off. Temperatures over 55°C will revert to 55°C when power and/or priority is regained.
- Operating **NOISE LEVEL IS VERY LOW**.
- **ERROR MESSAGES ARE DISPLAYED** on the Temperature Controllers, assisting with service.
- **FROST PROTECTION** device built in as standard.

IMPORTANT INFORMATION

Excessively hot water is dangerous, especially for young children and the infirm. The water heater allows you to control the temperature of your hot water to safe levels.



Water temperature over 50°C can cause severe burns instantly or even death from scalding.

Children, disabled and the elderly are at the highest risk of being scalded by excessively hot water.

Always test the temperature of the water before bathing or showering.

Burns from hot water taps can result in very severe injuries to young children.

Hot water at 65°C can severely burn a child in less than half a second. At 50°C it takes five minutes.

Burns can occur when children are exposed directly to hot water or when they are placed into a bath which is too hot.

DO

Do stay with children whenever they are in the bathroom.

Do take them out of the bathroom if you need to answer the phone or door.

Do test the temperature of the water with your elbow before placing your child in the bath.

Do make sure that the tap is turned off tightly.

Do consider setting your Rinnai Infinity or HD50i at a maximum temperature of 50°C.

Do install a child proof tap cover OR,

Do install a child resistant tap.

- **Consider child—resistant taps or inexpensive tap covers**, both of which prevent a child's hand from turning on the tap.
- **Consider reducing the temperature of the water supplied to the hot tap to 50°C.**

This approach can be extremely valuable because it requires a one time action for a long term reduction in risks of scalds. This type of automatic protection is important during times when a parent or carer has been distracted.

DO NOT

Do not leave a toddler in the care of another small child. The older child may not have safely set the temperature.

IMPORTANT INFORMATION

Always check water temperature before use.

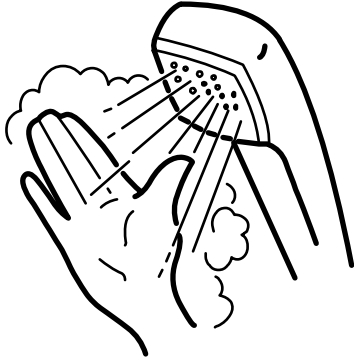

Refer to warning about hot water on page 16 for important safety information.

Hot water may go cold without warning at very low water flows (less than 3 l/min.)

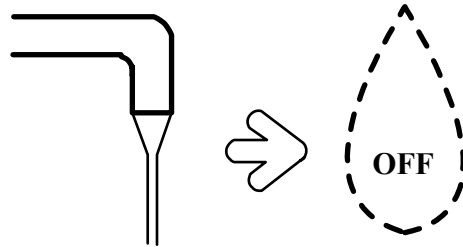

The **Infinity 16i** controls the water temperature automatically. For high temperatures it may reduce the flow. The water from the hot tap may be reduced after the temperature shown on the remote control is raised. The water flow may also vary with the temperature of the incoming water supply.

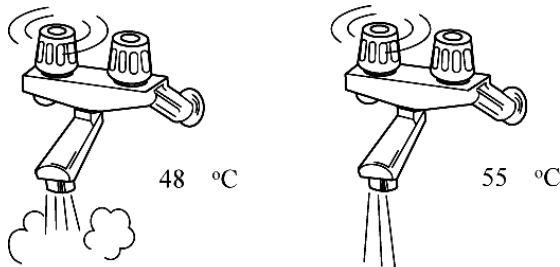

If freezing temperatures are expected, turn off the water and gas, and drain the water heater.

1. Water Off
2. Gas Off
3. Drain Water

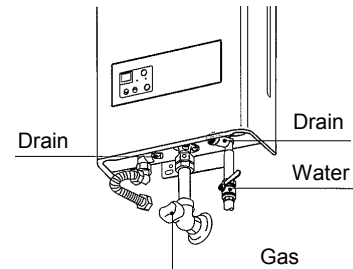

If the power is left on the Automatic Frost Protection will prevent the unit from Freezing. Frost protection is standard on all units.

Keep flammable materials, trees, shrubs, chemicals, etc. away from the flue outlet.



Do not touch the flue outlet. Do not insert objects into the flue outlet.



On cold days steam may be discharged from the flue outlet. This is normal, do not be alarmed. It does not indicate a fault.

OPERATION WITHOUT REMOTES

Rinnai Infinity products have no pilot light and operate automatically as soon as a hot water tap is opened.

The burner ignites with electronic ignition and the flame extinguishes as soon as water flowing through the appliance stops.

Turn On by opening the hot water tap

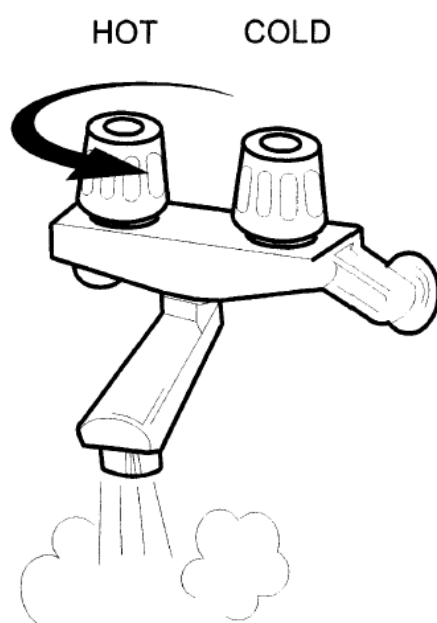

The Rinnai Infinity 16i water heater has a built in controller on the front cover for adjusting the temperature. Additional remote controllers are available to locate near the points of use, and give precise digital temperature control.

Controllers can be easily added at any time after installation.

TEMPERATURE CONTROLS

The purpose of a Temperature Controller is to enable the user to have complete control over the hot water supply. Used correctly, the Infinity will supply hot water at the temperature selected, even when the water flow is varied, or when more than one tap is used. Adjustments to the operation of your hot water unit can be made with any of the Temperature Controllers. Each Temperature Controller can be individually programmed.

Up to three Temperature Controllers can be fitted with the Infinity 16i. One of these controllers comes as standard mounted on the water heater. Additional Temperature Controllers are an optional extra.

The controllers have temperature selection, water flow volume, and water supply temperature functions.

Various water temperatures (°C) can be selected as follows:

35, 37, 38, 39, 40, 41, 42, 43, 44, 45, 46, 47, 48, 50, 55, 60°C

75°C can be set on the dip switches.

When the remote is turned on the temperature will default to 40°C.

While the hot water is running, the maximum selectable temperature will be 48°C. This provides additional safety for the consumer.

Suggested temperatures are:

Kitchen 50°C - 60°C; Bathroom 39°C - 43°C

These temperatures are suggested starting points for selection. You may find higher or lower temperatures are more comfortable. Maintaining lower temperatures helps to save energy. To obtain water temperatures lower than 35°C simply add cold water.

Up to three controllers can be used for one Infinity 16i. When multiple temperature controllers are used the only remote that can change the temperature is the one with priority. This is shown by the lit priority indicator. When the Kitchen Controller has priority the other remote's priority indicator will go out. When the Bathroom Controller has priority the other remote's priority indicator will flash. A different remote can only take priority of the system by pushing the priority button when the priority lamp is out. This means that while the Bathroom Controller has priority no one else can alter the temperature.

To take priority with the Kitchen Controller from the Bathroom Controller the priority button on Bathroom Controller must be pressed to give priority away.

The temperature selected by the controller with priority will be available to all outlets.

TEMPERATURE CONTROLS - OPERATING

Remote temperature controllers are a feature that provides control over the water temperature. The Rinnai Infinity 16i water heater can be operated with 1, 2, or 3 temperature controllers. The controller MC-45-SR-EU comes as standard with this water heater installed into the front panel.

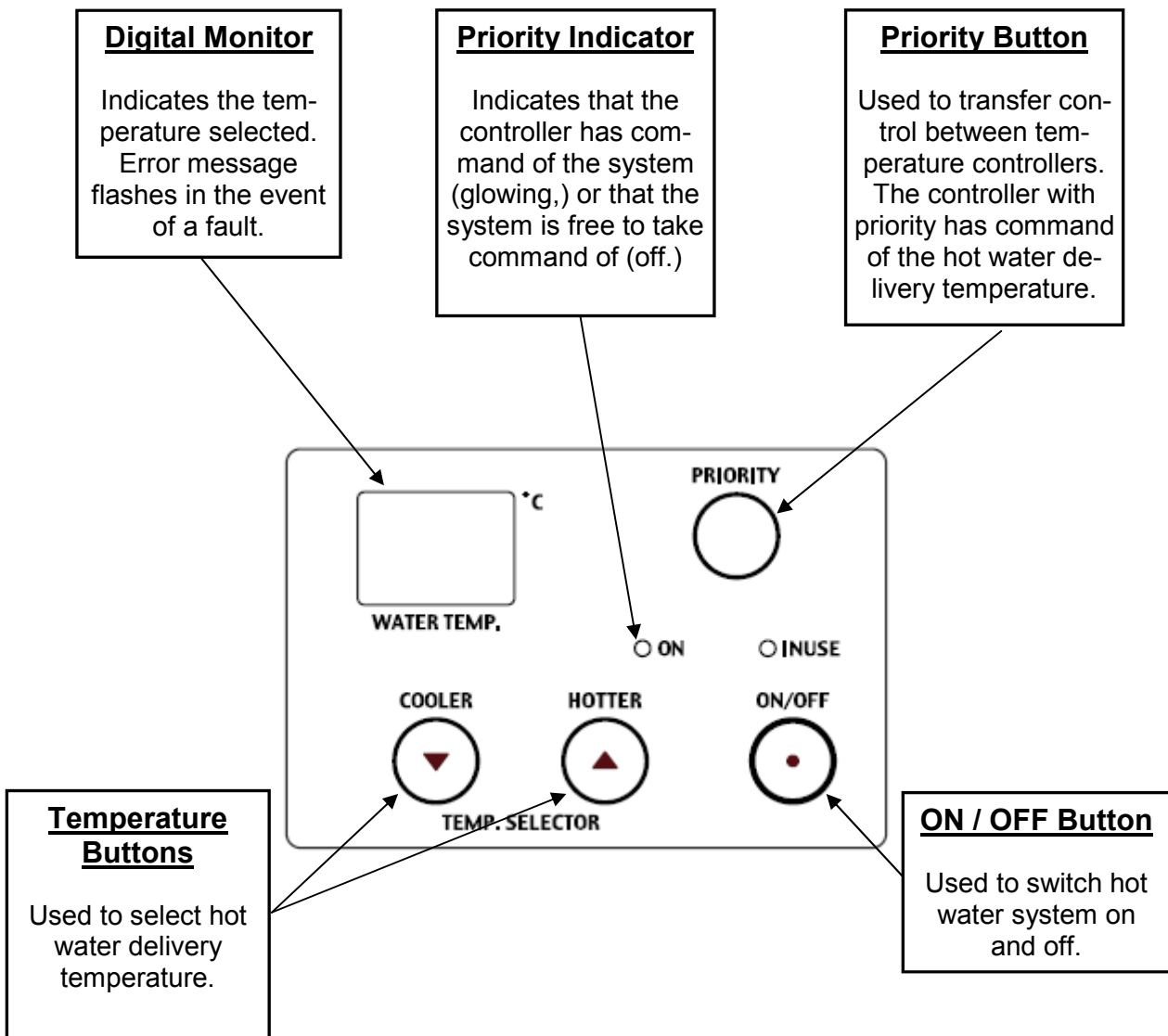

NOTE:

Each time a button is pressed, a BEEP will sound.

The BEEP sound can be muted by depressing the Temperature Controller Up and Down buttons simultaneously for more than 3 seconds until the controller beeps.

This can be done for each Temperature Controller.

To return to original settings, repeat this step.

TEMPERATURE CONTROLS - OPERATING

Using the Temperature Controllers.

Press the **ON/OFF** button on a temperature controller. The system will become active, the temperature will default to 40°C and the controller that turned the system on will have priority. The temperature setting on the controller will light up.

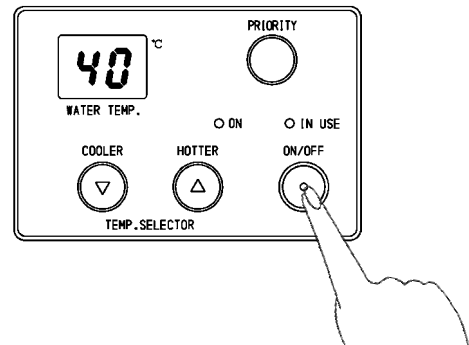

Adjusting Temperature

Simply press the Hot Water Temperature Up or Down arrow button until the desired temperature is displayed on the digital display.

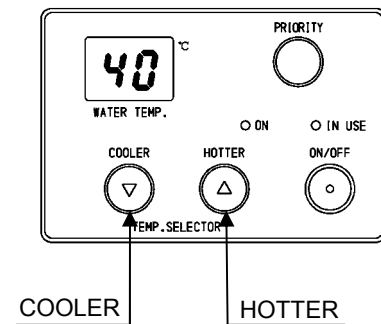

To operate the heater, simply turn any hot water tap on. This will automatically light the burner providing hot water. The red **IN USE** indicator will glow amber on the temperature controller.

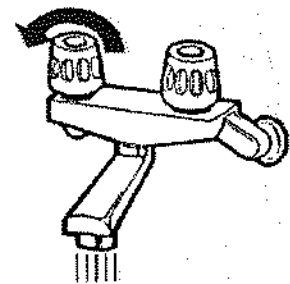

Caution: Always check water temperature before use.

Note: With the hot water tap open a temperature of 50°C or higher can not be selected. For safety reasons temperature 'priority' cannot be transferred between controllers when a hot water tap is open.

TEMPERATURE CONTROLS - OPERATING

Using 2 or more Temperature Controllers.

Switching the system ON.

The hot water system and all controllers can be switched ON and OFF from any controller by pressing the **ON/OFF** button as shown. When the system is turned ON the water temperature display will be lit.

During normal operation the system is left ON. Do not push the **ON/OFF** button when water is running.

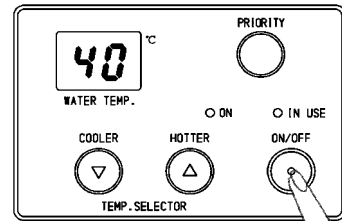

Ensure the system is switched **On** by verifying the temperature display is lit. Ensure the controller has priority by verifying the **ON** LED indicator is lit. If it is not then press the **Priority** button once. This gives the local controller priority of temperature over the system.

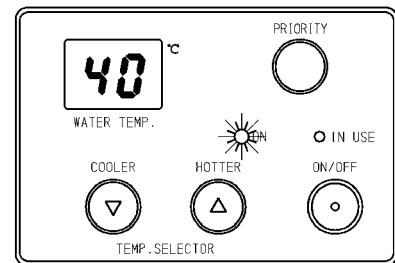

Select the desired temperature using the **TEMP. SELECTOR** buttons. The selected temperature will be displayed on all controller displays. This is the water temperature which will be supplied from the heater.

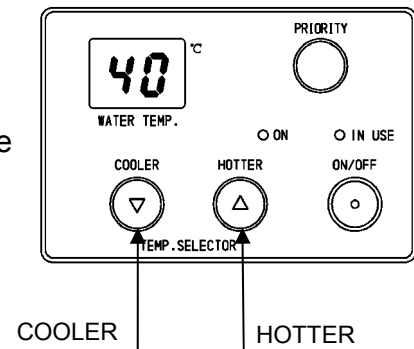

Using hot water.

Open the hot water tap. The appliance will be activated and the **IN USE** indicator will be lit.

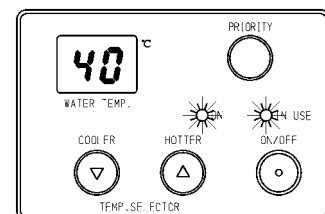

When temperatures 50°C and above are chosen the High Temp lamp will be lit.

Bathroom temperatures should be no more than 50°C.

TEMPERATURE CONTROLS - OPERATING

To turn off your hot water system.

During normal operation the system is left on.

To turn the system off simply press the **ON/OFF** button on any temperature controller (where fitted). This will shut the water heater down completely including the temperature controller digital display.

The Digital Monitor will go out.

If hot water taps are opened when the Rinnai Infinity is off, cold water will flow from the taps.

If the system is to be left off over the winter be sure to drain it down if there is a possibility of freezing temperatures.



Additional safety features.

Whilst the hot water tap is open, the following safety features apply:

- Temperature selection cannot be transferred.
- If a temperature of 50°C or higher selected, and the temperature is decreased to below 50°C, and then raised again the maximum available temperature will be 50°C.
- Other controllers are unable to change the delivery temperature of the water.

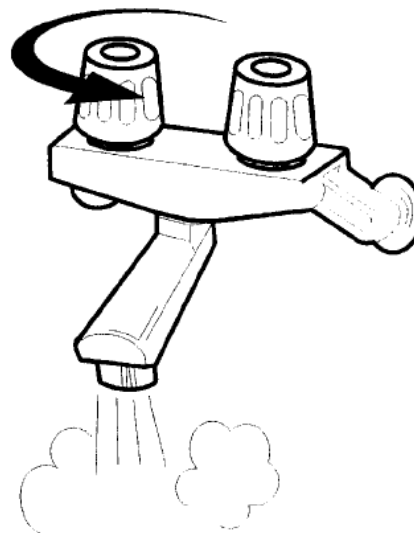

Note

The temperature of the outgoing water is constantly monitored by a built in sensor. If the temperature of the outgoing hot water rises to more than 3°C above the selected temperature shown on the digital display, or the preset limit if controllers are not fitted, the burner will automatically go out. The amber operation indicator will also go out. The burner will ignite again once the outgoing hot water temperature falls to that shown on the digital display (or the pre-set limit of the Rinnai Infinity heater).

TEMPERATURE CONTROLS - INFORMATION

Do not push the ON/OFF button on the Master controller after transferring priority of temperature selection to a Secondary controller as the system will shut down.

Do Not Turn OFF
the Master
Controller

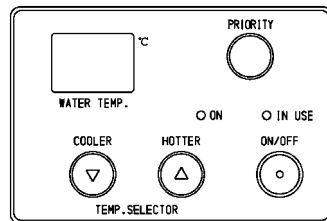

Temperature priority can not be switched to another controller when the water is flowing through the water heater.

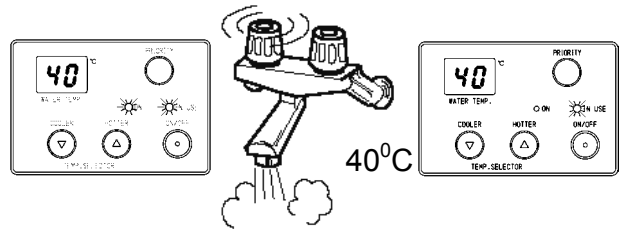

Controller 1
in use

Controller 2
cannot take
priority

If a temperature 50°C or higher has been selected on a controller and priority of temperature selection is transferred to another controller, then back again, the temperature on the controller will automatically drop to 50(or 42)°C. If the set point is 50(or 42)°C or less it will not alter. This is a safety feature.

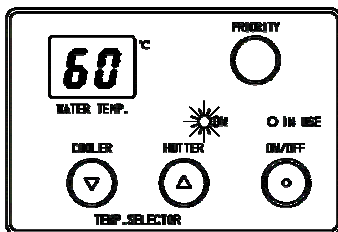

First
Controller

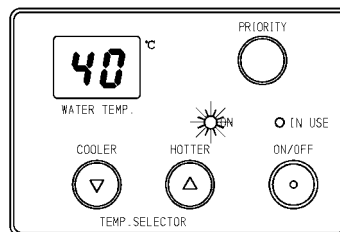

Another
Controller

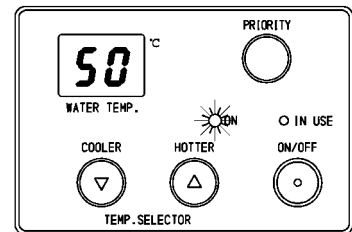

First
Controller

Depending on the weather conditions and the length of the pipe between the heater and the tap in use, there may be a variation between the temperature displayed at the controller and the temperature at the tap.

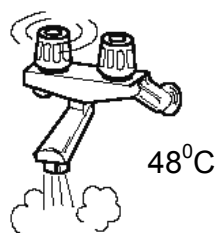
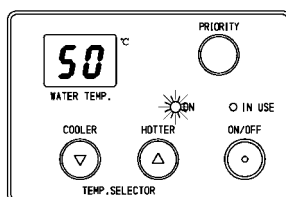

Do not clean the control with solvents or detergents. Use only a soft damp cloth.

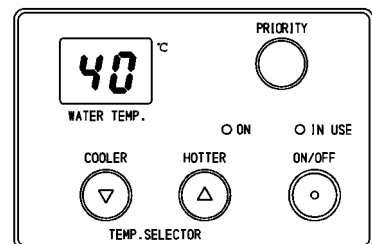

CARING FOR THE INFINITY

Maintenance

Even if there does not seem to be a problem with the water heater it is required in the UK that all gas appliances are serviced every year by a certified gas engineer. This is to ensure continued safety of the gas appliance. If you need a recommended service engineer contact Rinnai or your supplier.

Care

When the appliance casing, operation panel, and remote controls surfaces become dirty gently wipe them clean with a soft, damp cloth. Do not use detergents on these parts.

ERROR MESSAGES

Rinnai water heaters have the ability to check their own operation continuously. If a fault occurs, an error code will flash on the Digital Display if you have temperature controllers installed. This assists with diagnosing the fault, and may enable you to overcome a problem without a service call. Please quote the code displayed when enquiring about service. Some of these remedies can not be checked by the user because they require the front to be taken off of the unit. They are included so that you can give the information to the gas engineer.

Code Displayed	Fault	Remedy
-	Noticeable reduction in water flow	Inlet water filter needs to be cleaned.
10	Not enough combustion air	Check for physical blockages around air intake or exhaust. Check combustion fan.
11	No Ignition / Gas supply	Check gas valves, gas supply and ignition unit.
12	Flame failure / Earth Leakage	Check gas valves and gas supply. Check flame rod. Check earth wire lead. Check remote control.
14	High flame safety device	Check overheat circuit
16	Over temperature warning	Modulating control valve problem or water flow control valve problem
32	Outgoing water temperature sensor faulty	Check Hot Water Thermistor and wire
34	Combustion Air temperature sensor faulty	Check Air Intake Thermistor and wire
52	Gas modulating valve faulty	Check gas modulating valve and pcb.
61	Combustion fan failure	Check Combustion Fan
71	Micro-processor failure or Solenoid circuit failure	Check solenoids and pcb.
72	Flame rod circuit error	Check flame rod and pcb.

* In all cases, you may be able to clear the Error code by turning the hot water tap OFF, then ON again. If this does not clear the error, try pushing the On/Off button OFF then ON again. If the Error Code still remains contact Rinnai or your nearest service agent for advice.

** Faults caused by insufficient gas/water supply or gas/water quality and installation errors are not covered by the manufacturer's warranty.

Regular maintenance should be performed by a competent person in accordance with the local regulations at least once annually.

ERROR MESSAGES

Troubleshooting without controllers

If you have not installed temperature controllers and experience the following symptoms, please carry out the suggestions below. If symptoms continue, please contact Rinnai for advice.

Fault	Remedy
Heater does not attempt to start at all.	Check the power is on at the heater. Check the cold water valve supplying the heater is open.
Heater starts then shuts down immediately.	Check the power is on. Check the gas valve at the heater and at the gas meter is fully open. Open the hot water tap fully.
Heater starts then the water goes cold.	Check the power is on. Open your hot water tap further or try another hot outlet.

NOTE: Faults caused by insufficient gas/water supply or gas/water quality and installation errors are not covered by the manufacturer's warranty.

Installations with circulation pumps

With temperature controller fitted.

If you have an installation using a secondary circulation pump this must be switched off so that there is no flow through the heater when starting or after a power failure. If the pump is running the unit will not operate (no display on the controller). Isolate pump then start heater before restarting pump. This is a safety feature.

The pump should also be fitted with a thermostat to prevent the return temperature reaching the heater set point temperature.

Without temperature controller fitted.

The heater should automatically reset and provide water at the temperature set by the internal limit switches.

RESTARTING THE RINNAI WATER HEATER

Following a power cut the heaters should be restarted in this manner.

Standard system.

Single or multiple water heaters without remote controllers.

The heaters will automatically reset without any user involvement.

Single or multiple water heaters with remote controllers.

The heaters will be required to be switched on using the ON/OFF button on a remote controller. Ensure that all taps/water outlets are closed and no water is flowing through heaters.

Hot water system incorporating secondary recirculation pump.

Single or multiple water heaters without remote controllers.

The heater(s) will automatically reset without any user involvement.

Single or multiple water heater(s) with remote controller(s).

To reset the heaters follow the steps.

1. Turn off all hot water taps.
2. Turn off supply to secondary circulating pump or alternatively, if heater and pump are fed from the same electrical supply, isolate pump flow.
3. Turn on heater at remote control.
4. Select required temperature.
5. Switch on supply to secondary circulating pump or open valve on pump flow.

The heater will now be ready to supply water at the set temperature.

If following the above procedure does not reset the heater switch it on and off at its main supply, and then go through these steps again. If heater is still not working call your local service agent or Rinnai for assistance.

INSTALLATION INSTRUCTIONS

STOP

To go beyond this point in the manual you must be a registered gas engineer.

Do not attempt to install this appliance if you are not qualified.

If the information in this manual is not followed exactly a fire or explosion could result.

This manual must be read in its entirety before installing the appliance.

If you are unsure of any point contact Rinnai or your supplier.

UK INSTALLATION INSTRUCTIONS

IMPORTANT INFORMATION

This appliance may only be installed by someone certified competent to do so. At the time of printing the only people deemed competent to install this appliance are those that are CORGI registered for this type of appliance in this type of location who have a current ACS certificate.

1. **Gas safety (Installation & Use) regulations 1998** are the 'Rules in force'. In your own interest and that of safety, it is law that all gas appliances are installed by competent persons in accordance with the above regulations. Failure to install appliances correctly could lead to prosecution. Other persons should NOT attempt to install this equipment.
2. **Building Regulations G3** require installers of unvented systems to be competent to do so. Competence can be shown by holding a current certificate in Unvented Domestic Hot Water Systems. If the Infinity is installed in a flow and return, or tank system, or any other closed system then the system is unvented.
3. Installation must be carried out in accordance with the current issue of the following:

Building Regulations issued by the Department of the Environment

Building Standards (Scotland) Regulations.

I.E.E. Wiring regulations for electrical installations.

Gas safety (Installation and Use) Regulations current issue.

BS 5546

BS 5440

BS 6891

BS 5482

BS 6700

BS 6644

Institute of Gas Engineers Publications

Local byelaws

Water regulations

Health and safety at work etc. Act 1974

IGE/UP/10 Part1 Edition 2.

Building Regulation J



Such other specifications and regulations that may supersede or complement the above documents.

Please be sure that you are fully aware of your obligations and responsibilities under these regulations.

UNPACKING RINNAI WATER HEATER

- After unpacking the appliance check for damage, if the heater is damaged or appears to have any defects contact your supplier immediately. DO NOT install a damaged appliance before checking with your supplier.
- A heater accessories pack is inside the carton. One remote control is supplied with the Infinity 16i.
- Check that the appliance supplied is the correct gas type for the installation. Refer to the data plate located on the left-hand side of the appliance.
- Remove the heater and the accessories from the carton, and check that all the parts are included. The remote control cable is provided with spade connectors.

Unit Mounting Fasteners

Quantity	Diagram	Description
5		Screw
5		Wall Plug

OPERATION PRINCIPLE

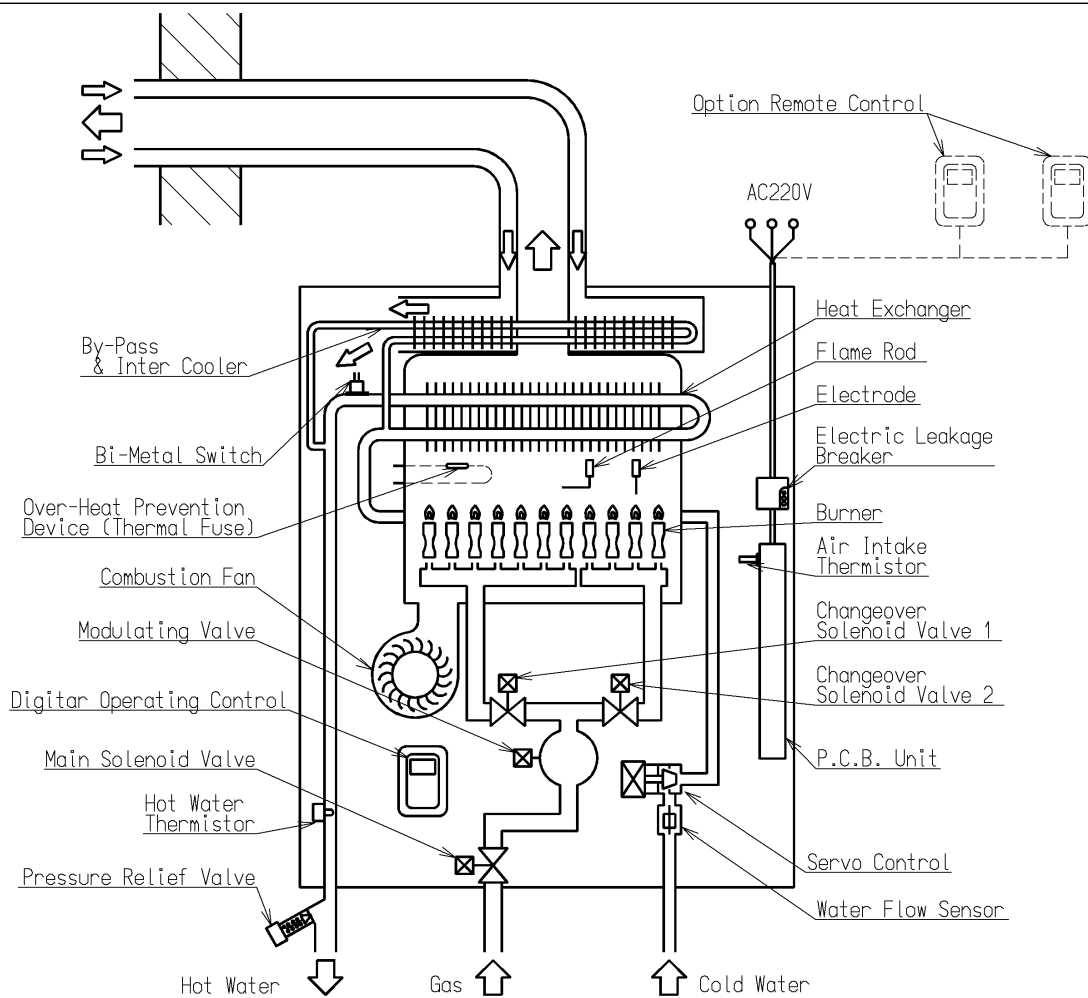

HOT WATER SUPPLY OPERATION

Ignition

Press ON/OFF Button of **Remote Controller** to turn on unit and the remote controller display and priority LED will light up.

When a hot water tap is opened the **Water Flow Sensor** revolves and sends a pulse signal to the **Printed Circuit Board (PCB.)** When the PCB detects water flow it begins the ignition process with the **Combustion Fan Motor** starting first.

Once the air proving is made the **Main Solenoid Valve** and **Change-over Solenoid Valves** are opened and the **Burner** is lit by the sparking **Igniter**.

Temperature Setting

With the Temperature Control Buttons on the remote controller the outlet temperature can be set from 37 - 60°C. When the temperature set point is above 50°C the High Temperature Indicator glows.

Temperature can not be set above 50°C while hot water is in use.

Standby

When the hot water tap is closed the PCB no longer receives a pulse signal from the Water Flow Sensor. The PCB shuts the Main Solenoid Valve and Change-over Solenoid Valves and the Burner extinguishes.

MAIN COMPONENTS

1. Gas Control Unit

1.1 Modulating Valve

This device is used by the PCB to adjust the volume of gas to the burner in proportion to the volumetric flow rate of water in order to maintain a supply of constant temperature hot water amid changes in water flow rates and incoming temperatures.

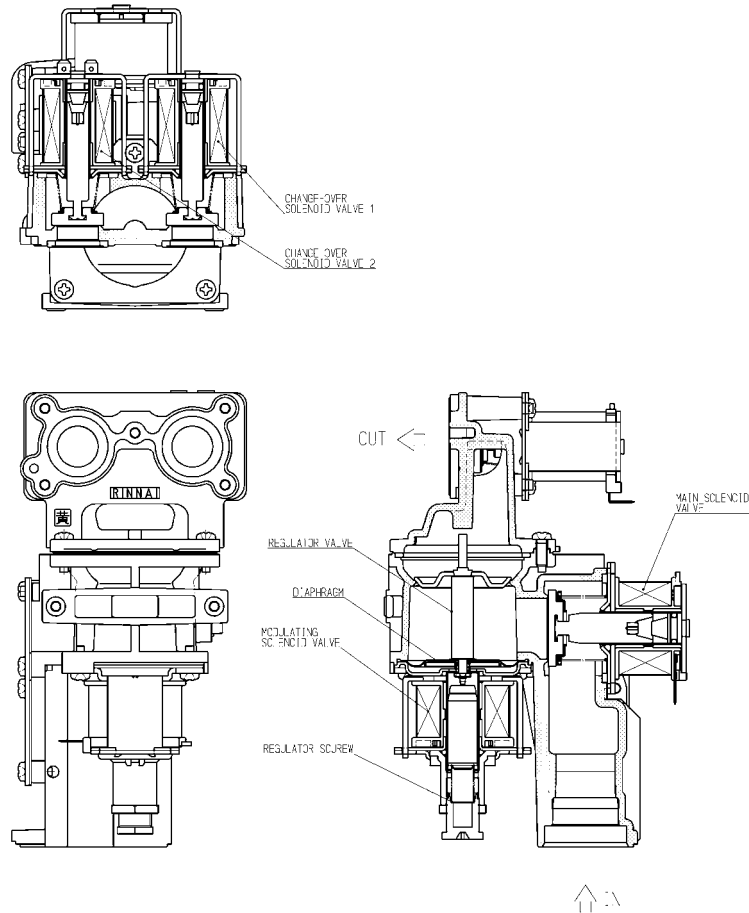

1.2 Change-over Solenoid Valves

Additional solenoid valves are included to section the burner and stage the control in 3 steps. This gives the Burner more steady combustion at the required capacity and allows the water heater to operate at very low flow rates and temperature rises.

2. Flame Rod

Monitors combustion characteristics inside the combustion chamber. If the flame fails, gas supply is stopped. Works through rectification of the combustion flame. An AC voltage is supplied to the flame rod. Electrons can only pass from the rod to the flame, and never from the flame to the rod, so the resultant DC current is used to prove combustion. When the DC current is present the burner has normal combustion, if the DC current is not present the unit shuts the solenoid valve.

MAIN COMPONENTS

3. Thermal Fuse

The thermal fuse is an electric link which must be intact for the unit to operate. If the thermal fuse reaches a set temperature it will melt and the unit will shut down. The thermal fuse must be replaced if it melts. It is to protect against over heating and heat exchanger splits where water may leak out and be super heated into steam.

4. Overheat Safety (Bi-metal Switch)

This Bi-metal Switch is fixed at the bend of the Heat Exchanger hot water outlet. If the temperature outlet from the heat exchanger reaches 95°C the bi metal switch will open and the solenoid valve circuit is broken. This will cease combustion in case of overheat.

5. Combustion Fan

The combustion fan supplies primary air into the wing burners and secondary air up through the Bunsen style burners. The fan is DC low voltage and the speed is controlled by the PCB depending on the hot water supply and temperature. The fan speed is compared to the current required to attain that speed for air proving. If the fan current is over or under the parameters for the given speed the unit will shut down on air proving.

6. Water Volume Servo with Water Flow Sensor

6.1 Water Flow Sensor

Water flow sensing is done with a small turbine that spins when water travels through it in the correct direction. Each of the four fins on the turbine has a small magnet on it. Outside of the valve there is a magnetic sensor that detects the speed that the turbine is revolving. The revolution speed is input to the PCB which relates this speed to the water flow volume and determines whether it is sufficient for ignition.

6.2 Water Volume Flow Servo

The water volume is adjusted by opening and closing the water flow valve with the servo motor. This will limit the maximum hot water flow to 20 L/min, and will limit the water flow further when the burner is at high fire to ensure the temperature setpoint it met.

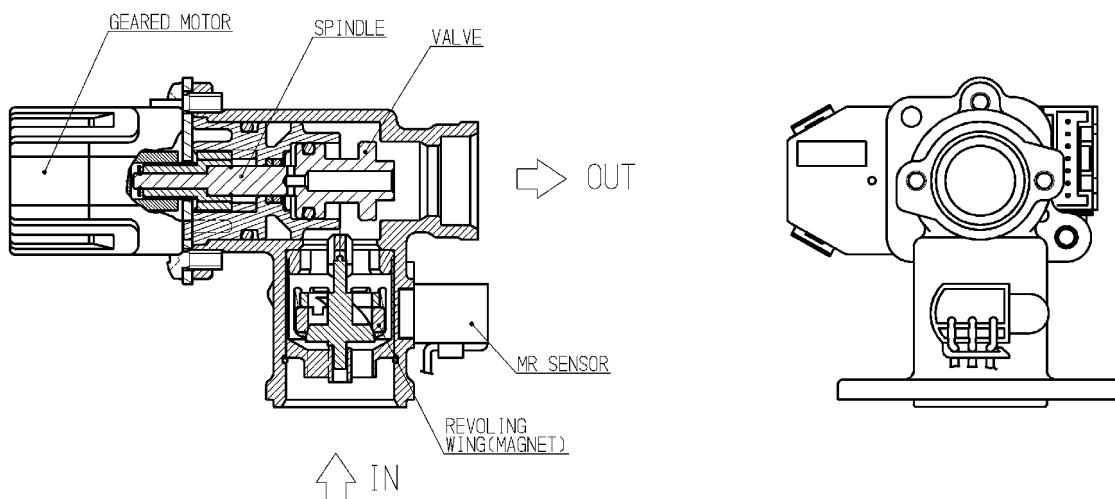

INSTALLATION INSTRUCTIONS - POSITIONING

Appliance Location.

The wall or structure on which it is mounted must be capable of supporting the weight of the appliance (15 kg) and associated pipework. Ensure that suitable screws or bolts are used to secure the water heater to the wall. Bracket and fixing hole locations are shown on the template included. The top bracket has a keyhole slot so that the appliance can be hung on one screw, and then the other fixings can be added to secure the unit.

The heater must be installed in the vertical position with the gas and water connections on the underside pointing vertically downward. The heater must be installed internally.

The appliance should be placed as close as practical to the most frequently used hot water outlet point or points to minimise the delay time for hot water delivery. For installations where the distance between the unit and hot water outlet points is considerable, the appliance can also be fitted in a 'flow and return system' which minimises the waiting time for hot water delivery. Alternatively, multiple appliances can be strategically placed to service outlet points with minimal delay time. Contact Rinnai or your supplier for further information.

When positioning appliance the flue terminal clearances must be in accordance with local requirements. Consideration should be given to other appliances, openings, and boundaries. Multiple heater installations can be installed with the heaters manifolded together. The minimum distance required between the heaters may then be based on the necessary clearances between flue terminals.

The appliance must be in an accessible location. Sufficient clearances shall allow access to, and removal of, all serviceable components. The following clearances should be followed.

If the unit is installed on a combustible wall such as wood there must be a 45mm gap between the wall and the back of the unit. Brackets are available to space the unit this far off of the wall.

In case the side wall next to the appliance is flammable material there must be at least 50mm between the side of the appliance and the combustible wall.

The illustration shows the clearances necessary for servicing, on a non-combustible wall.

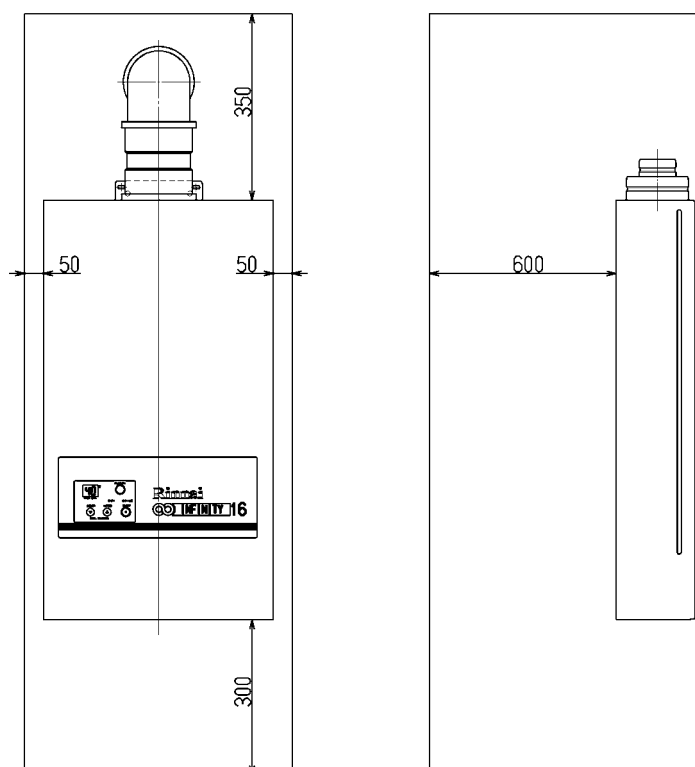

INSTALLATION INSTRUCTIONS - CONNECTIONS

Water Supply.

Where the water supply pressure exceeds 7 bar, an approved pressure reducing device is required at the inlet of the appliance. To achieve the maximum rated flow a minimum water supply pressure of 1.1 bar is required at the appliance inlet. The unit will operate at lower supply pressures but the maximum flow rate will not be achieved. Contact Rinnai or your supplier for 'gravity fed' or 'low pressure' hot water installations.

Water pipe sizing and layout should be designed correctly to ensure the given water flows from the appliance are available. All hot water pipework should be insulated to optimise maximum performance and energy efficiency.

Water Connection.

Connect the hot and cold water supply pipes as shown on the following page. An approved isolation valve and strainer MUST be installed in the cold water inlet pipe. An approved isolation valve and draining point should be installed in the hot water outlet pipe. There must be a union or release fitting on the heater side of the isolation valves. An unvented kit to local regulations must be installed in the pipework when the system is closed (i.e. has a flow and return, or tank.)

Positions of the cold water inlet, hot water outlet and gas connections are shown on page 41.

If the heater is in a hard water area a suitable water conditioning device should be installed to prevent the build up of limescale within the heat exchanger. Heat exchangers damaged by scaling are not covered by the manufacturer's warranty.

Description	pH	Total Dissolved Solids (TDS)	Total Hardness	Chlorides	Magnesium	Calcium	Sodium	Iron
Maximum Recommended Levels	6.5 - 9.0	600 mg/litre	150 mg/litre	300 mg/litre	10 mg/litre	20 mg/litre	150 mg/litre	1 mg/litre

Gas Connection

Check pipe sizing required for the heater input. The gross heat input for the Infinity 16i is 34.9 kW (G20); 29.6 kW (G25); 37 kW (G30, G31.) The size of the gas meter and pipework must be sufficient for all appliances on the main. Sufficient gas must be available at the appliance if correct operation is to be expected; insufficient gas will damage the unit. An approved gas isolation valve must be fitted at the gas inlet. A union or release fitting should be installed after the isolation valve.

Electrical Connection

The appliance must be earthed. The appliance is suitable for 230VAC – 50Hz mains only and all wiring must be carried out to local regulations.

UK INST. INSTRUCTIONS - CONNECTIONS

Water Connection.

For all closed systems (with flow and return or tank) the system must incorporate an unvented kit with the components shown below. The safety relieve valve must discharge safely into a suitable drain via tundish.

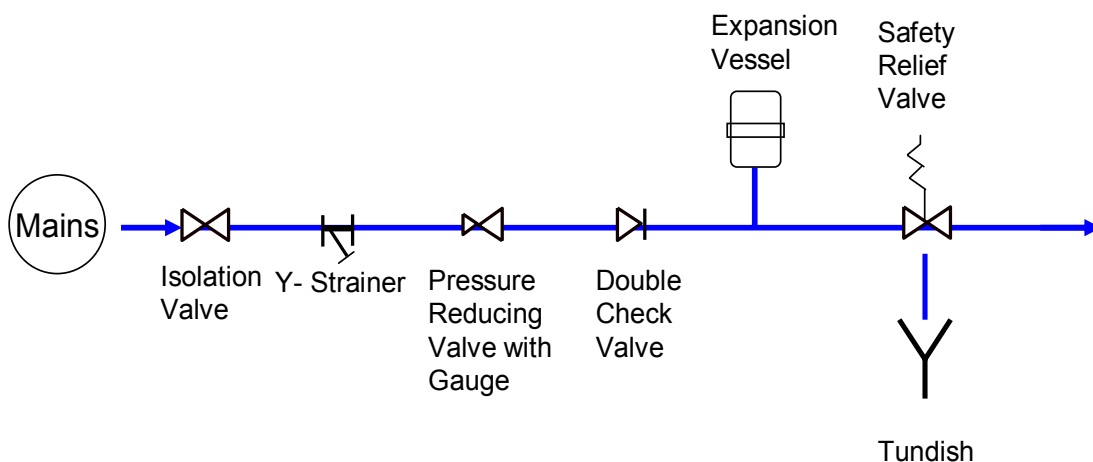

Gas Connection

Refer to BS6891 (Natural Gas) and BS5482 (Propane) for guidance on correct pipe sizing calculation. There must be 20 mbar Natural Gas (G20) or 34.5 mbar Propane (G31) at the inlet of the appliance with all appliances at high fire.

Electrical Connection

The heater electrical supply must be installed to the latest I.E.E regulations. If the unit is hard wired (moulded plug removed) it must be provided with a fused (3A) local isolator with a contact separation of 3mm minimum on all poles for servicing. Observe polarity and ensure that wiring is correctly restrained.

INSTALLATION INSTRUCTIONS - SCHEMATICS

Single Infinity Direct Flow

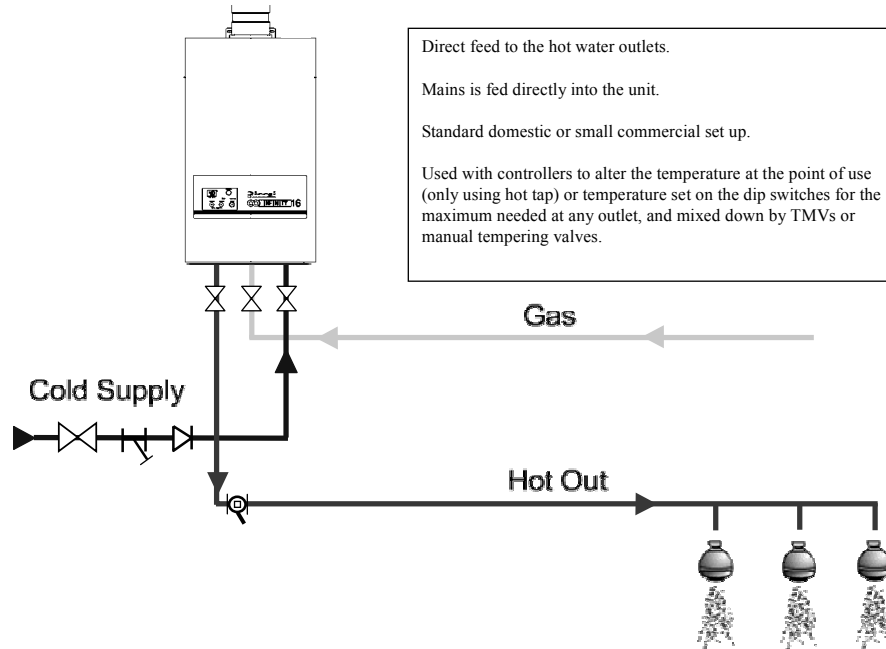

Direct feed to the hot water outlets.
 Mains is fed directly into the unit.
 Standard domestic or small commercial set up.
 Used with controllers to alter the temperature at the point of use (only using hot tap) or temperature set on the dip switches for the maximum needed at any outlet, and mixed down by TMVs or manual tempering valves.

This information is intended as a guide only, it does not imply compliance with water or gas installation regulations. Components will vary depending on the actual installation. Check local regulations before installation.

Draining Point

Hot Outlets

Manifolded Infinity x 2 With Pumped Secondary.

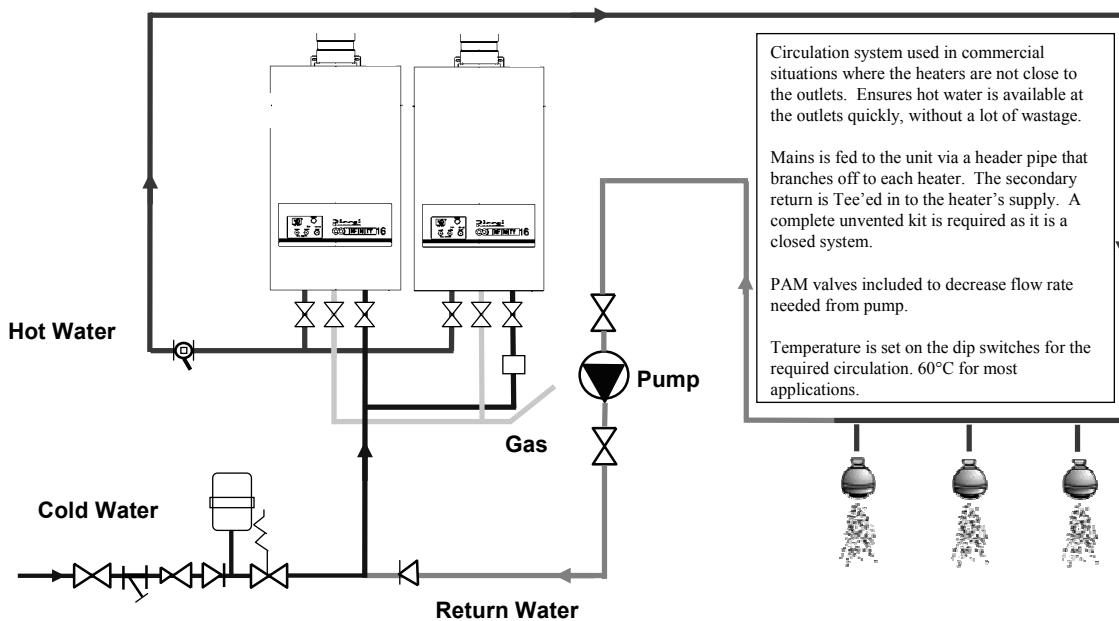

Circulation system used in commercial situations where the heaters are not close to the outlets. Ensures hot water is available at the outlets quickly, without a lot of wastage.
 Mains is fed to the unit via a header pipe that branches off to each heater. The secondary return is Tee'd in to the heater's supply. A complete unvented kit is required as it is a closed system.
 PAM valves included to decrease flow rate needed from pump.
 Temperature is set on the dip switches for the required circulation. 60°C for most applications.

This information is intended as a guide only, it does not imply compliance with water or gas installation regulations. Components will vary depending on the actual installation. Check local regulations before installation.

Draining Point	Valve	Pressure Reducing Valve	Strainer	Non-Return Valve	Safety Valve	Expansion Vessel	Flow Modulation Valve

UK INST. INSTRUCTIONS - VENTILATION

General Information.

This appliance must be installed in accordance with the rules in force. Consult instructions before installations and use of this appliance.

The unit must be installed by a competent, authorised person. It is the installer's responsibility to ensure that the unit has been installed to all current requirements.

The Rinnai Infinity 16i is a room sealed appliance. Ventilation requirements of BS 5440 allow room sealed appliances to be installed in spaces and rooms, including bedrooms, without ventilation.

If the Rinnai Infinity 16i is installed in a compartment it must have the following amount of permanent ventilation.

Ventilation from compartment to room:

320 cm² at high level AND
320 cm² at low level

Based on 10cm²/kW net heat input

Ventilation from compartment directly to outside:

160 cm² at high level AND
160 cm² at low level

Based on 5 cm²/kW net heat input

The area given is the free area of the vent or equivalent free area for ventilators of more complex design. Any space taken up by grille louvers should be subtracted from the total area to find the free area of the vent.

Windows and doors can not be considered ventilation unless they are permanently fixed in the open position.

Please refer to IGE/UP/10 Part 1. Edition 2 page 17 for further information or contact Rinnai UK.

FLUE REQUIREMENTS - INSTALLING

The flue must be installed by a competent, authorised person. It is the installer's responsibility to ensure that the unit has been installed to all current local requirements.

Ensure that the flue terminal and hot water outlet connection cannot be touched by children. The flue must be clear of obstructions and shrubbery.

Flue Length.

The flue Total Equivalent Length is limited to 6.5m. Each 90° bend should be considered 0.5m of the Total Equivalent Length. The maximum number of bends is 3.

Separate instructions are provided with the flue detailing the installation of the flue parts.

Flue pipes must include a condensate drain if the total flue height exceeds 1.5m. There is a special condensate drain collector piece available through Rinnai or your supplier. For flue runs requiring a drain the horizontal sections on the appliance side of any vertical runs should slope towards the appliance, and the flue should be bracketed to prevent sagging. If the terminal is horizontal it should slope gently to the outside to prevent ingress of rain.

The drain pipe should be run in 22mm PVC, uPVC, or ABS pipe, copper is not recommended. The drain pipe **MUST** be trapped. A trap with pipe is available from Rinnai or your supplier.

Although the flue and appliance have been specially designed to prevent condensation in the flue for short runs (under 1.5m) care should be given to the placement of the terminal to prevent risk in the unlikely event of condensation. Condensation water can cause burns, and during winter could cause a slip hazard. It is the responsibility of the installer to decide the best place.

FLUE REQUIREMENTS - INSTALLING

The following flue manufacturers with their specific brands listed below are approved for use with the Rinnai Infinity 16i water heater.

1. UBBINK

The following combinations of flue materials may be used with the Rinnai water heater

Rolux® flue system

Roof terminal black T200 L =1000 mm

Wall terminal T200 Alu 800mm black

Wall terminal T200 Alu 800mm white

2. Muelink & Grol

The following combinations of flue materials may be used with the Rinnai water heater

Walloutlet 60/100 type M 2000 with short bend adaptor.

Roofoutlet 60/100 type M 2000 incl. adaptor.

Roofoutlet concentric 80/125 type M 2000

Concentric air/flue system 60/100 and 80/125.

Vertical appliance adaptor 60/100

3. Groppalli

The following combinations of flue materials may be used with the Rinnai water heater

A03.001.000813: Coaxial 60/100 wall flue kit;

A03.001.000276: Coaxial 60/100 90° bend;

A03.001.000278: Coaxial 60/100 1.000mm L pipe.

B0N.006.000001 Adaptor Kit from 60/100 to 80/125

A05.023.000021 Roof 80/125 flue

A05.025.000002 Roof tile

UK FLUE REQUIREMENTS - INSTALLING

The Rinnai Infinity 16i is for internal installation in conjunction with the Rinnai flue system

The flue must be installed in accordance with:

Manufacturers Installation Instructions
British Standards including BS5440
Gas Safety (Installation and Use) Regulations
IGE/UP/10 Part1 Edition 2.
Building Regulation J

Such other specifications and regulations that may supersede or complement the above documents.

The flue must be installed by a competent, authorised person. It is the installer's responsibility to ensure that the unit has been installed to all current requirements.

Location of the appliance flue terminal must be in accordance with the clearances shown in BS5440-1:2000. Table and Figure C.1 is provided for your guidance on page 33.

When multiple room sealed forced draught terminals are installed together there must be enough of a gap to satisfy the requirements of the regulations. Under current regulations the terminals must have at least a 300mm gap between them. The flue terminal should be over 2m from ground level whenever possible. For lower installations a terminal guard must be installed.

UK FLUE REQUIREMENTS - POSITIONING

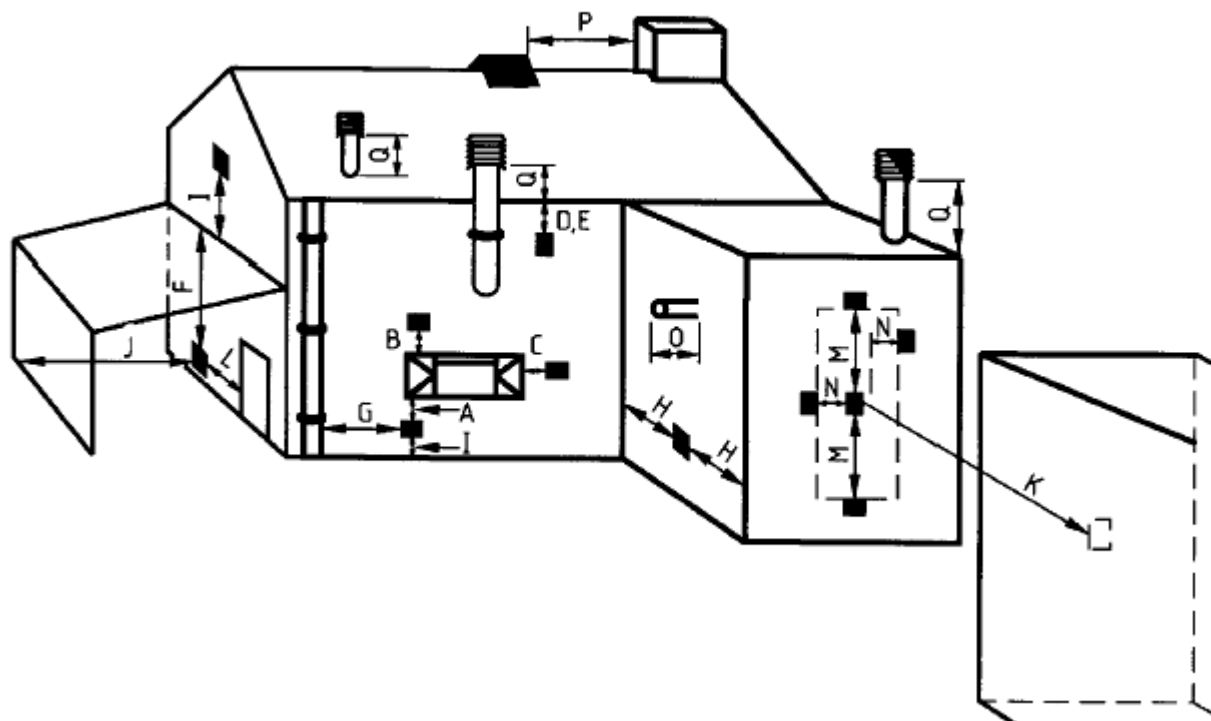

Dimension	Terminal Position	Distance
A	Directly below an opening, air brick, opening windows, etc.	300mm
B	Above an opening, air brick, opening window, etc.	300mm
C	Horizontally to an opening, air brick, opening window, etc.	300mm
D	Below gutters, soil pipes or drain pipes.	75mm
E	Below eaves.	200mm
F	Below balconies or car port roof.	200mm
G	From a vertical drain pipe or soil pipe.	150mm
H	From an internal or external corner.	200mm
I	Above ground, roof or balcony level.	300mm
J	From a surface facing the terminal.	600mm
K	From a terminal facing a terminal	1200mm
L	From an opening in a car port. (eg door, window) into a dwelling	1200mm
M	Vertically from a terminal on the same wall.	1500mm
N	Horizontally from a terminal on the same wall.	300mm
O	From the wall on which the terminal is mounted	N/A
P	From a vertical structure on the roof.	N/A
Q	Above an intersection with roof.	N/A

TEMPERATURE CONTROLS - INSTALLATION

When deciding on the best position for the temperature controls, the following points should be taken into account.

- Fit the controls out of reach of children (suggested height from the floor 1.5m.)
- Avoid positions where the controllers will become hot. Do not fit them near stoves or ovens, or above radiators or heaters.
- If possible, avoid exposure to direct sunlight or positions where bright lights will make the digital display difficult to read.
- Position away from areas where the controller will be prone to splashing by cooking products such as oils and fats.
- The temperature controllers are water resistant, however they should be positioned away from areas where direct or persistent splashing could occur.
- Refer to the local electrical wiring regulations current edition for location requirements in shower and bath areas.
- The cables to the temperature controller carry only 12VDC (extra low voltage.)
- When using more than one temperature controller the signal cable should be run in parallel. That is, from controller to controller to heater, or from each controller to the heater. Do not wire the controllers in series.

The installation in every application will vary, therefore the temperature controller cable has been provided so that you may cut the length accordingly and fit the spade connectors, ensuring a good connection.

Cables are simply 'piggy-backed' at the water heater or at the primary temperature controller. Polarity is not important when connecting the cables, either colour wire can be connected to either terminal at both the heater or primary temperature controller. If more cable is needed any cable with similar specification to the cable supplied with the controller can be used. Maximum length is 50 metres.

TEMPERATURE CONTROLS - INSTALLATION

Temperature Controller MC-45-SR-EU / BC-45-SR-EU / BSC-45-SR-EU

1. Determine the most suitable position for the temperature controller.
2. Drill 3 holes in the wall as shown in fig. 1, one for the cable and two for the securing screws. Ensure holes are drilled deep enough. Fit wall plugs if needed. (ensure controller is level.)
3. Remove the face plate from the controller using a flat screwdriver. Take care not to damage the cover (fig. 2.)
4. Run the cable provided through the hole in the wall and connect to the controller. (fig. 3.)
5. Connect the cable to the temperature controller. If the cable cannot run in the wall cavity the plastic side or bottom knockout should be removed.
6. Fix the controller to the wall and fasten with the phillips head screws supplied as shown in (fig. 4.)
7. Replace the face plate.

Connecting Additional Controllers

Additional controllers are installed in the same manner.

Cables should be run in parallel, either from one controller to the next, or all controllers back to the Infinity.

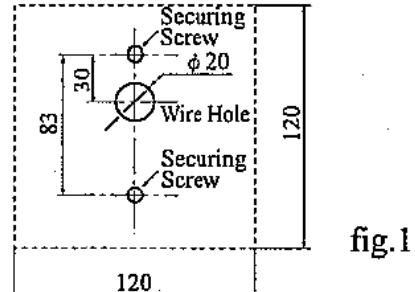

fig.1

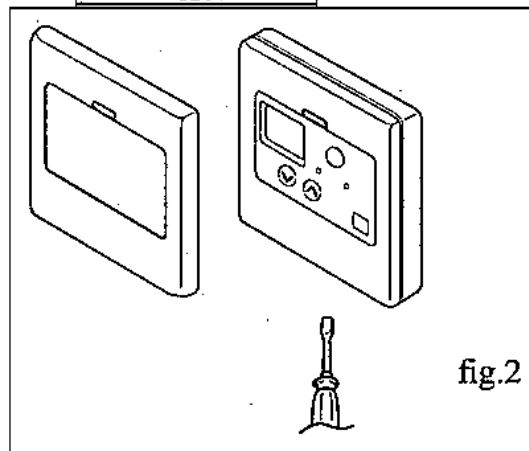

fig.2

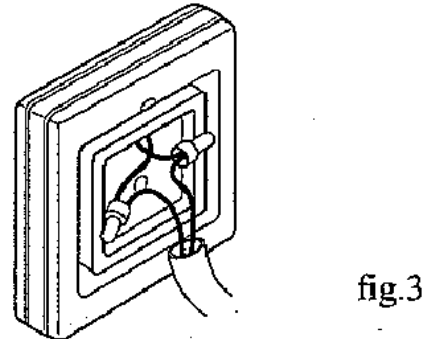

fig.3

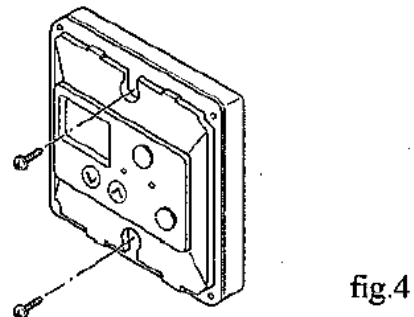

fig.4

TEMPERATURE CONTROLS - INSTALLATION

Connecting the Controllers to the Infinity

1. Isolate the power supply.
2. Remove the front cover from the Appliance (2 screws) Fig. 1.
3. Thread the cable through the cable access hole at the base of the appliance.
4. Connect the cables to the Remote Control cable unit as in Figure 2. Either wire can be connected to either wire. This is available for up to three controllers.
5. Secure cables inside appliance using the clamp provided.
6. Replace cover of the Appliance.

Fig. 1

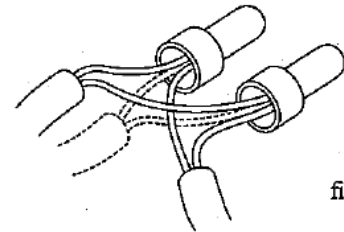
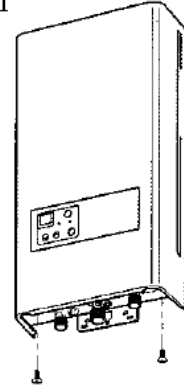

fig.2

TESTING



1. Purge gas, hot water and cold water supply lines before making the final connection of the water heater. Swarf in either the gas or water supplies may cause damage.
2. Turn on gas and cold water supplies.
3. Test for water leaks and gas escapes near the unit.
4. Isolate gas and electric supply. Remove test point screw located on the inlet gas pipework below the heater and attach pressure gauge.
5. Turn the power on at the switch and turn on gas. **Warning:** There are 230V AC live supplies inside the heater.
6. If remote controllers are fitted, turn the controller on, select the maximum delivery temperature and open ALL available hot water outlets. If remote controllers are not fitted, simply open all available hot water outlets. (CAUTION: Ensure building occupants do not have access to hot water outlets during this procedure).
7. The gas pressure check must be carried out with all other appliances on the same main operating at maximum capacity to ensure that there is sufficient gas pressure.
8. With all appliances on the same main operating at high fire check the pressure at the test point on the inlet to the gas valve. The pressure must be within the local defined limits for the type of gas that is being used. If the pressure is lower, the gas supply is inadequate and the water heater will not operate to specification. Check gas meter, regulator and pipework for correct operation/sizing and rectify as required. Note that the gas regulator on the appliance is electronically controlled and factory pre-set. Under normal circumstances it does not need adjustment during installation.

UK the gas pressure must be at least **20 mbar** for G20 Natural Gas as used in UK. For G31 Propane as used in the UK the pressure must be at least **34.5 mbar**.
9. Close hot water outlets.
10. Inspect and clean the strainer and the filter located on the cold water inlet pipe. This procedure may need to be repeated to ensure the strainer remains clear.
11. If temperature controllers are fitted, it is necessary to test their operation through the complete range of functions.
12. Confirm the hot water delivery temperature using a thermometer. If controllers are fitted, compare the measured value to the set point.
13. After testing is completed, explain to the user the functions and operation of the water heater and temperature controllers.

GAS PRESSURE SETTING

The working gas pressure on the water heater is electronically controlled and factory set. Under normal circumstances it **does not** require adjustment during installation. Perform this procedure only if the unit is not operating correctly and **all** other possible causes for incorrect operation have been eliminated. **Contact Rinnai before attempting to alter the gas pressure. Failure to do so could void the warranty.**

1. Turn 'OFF' the gas supply.
2. Turn 'OFF' 230V power supply.
3. Remove the front cover from the appliance.
4. Check gas type dip switches no.1 and no. 2 are in the correct position for the type of gas (Nat. or LPG)* you are using. See Fig. 1

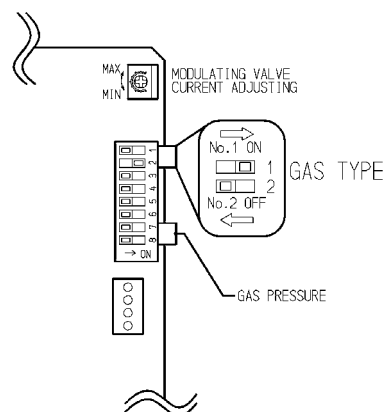

Fig. 1

off	on	SW		off	on	SW	
		1	-Nat. Gas			1	-LPG
		2	-Nat. Gas			2	-LPG
		3				3	
		4				4	
		5				5	
		6				6	
		7				7	
		8				8	

On is in the right hand position, Off is in the left hand position.

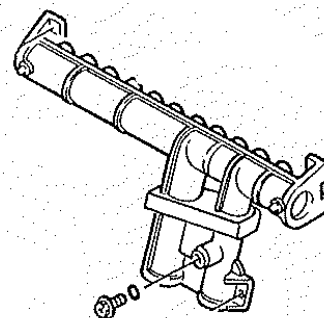

Fig. 2

5. Attach pressure gauge to burner test point. (Fig. 2)
6. Turn 'ON' the gas supply.
7. Turn 'ON' 230V power supply.
8. If remote controllers are fitted, turn the unit 'ON' at the controller and select a maximum delivery temperature.
9. Open a hot water tap fully. **(CAUTION: Ensure building occupants do not have access to hot water outlets during this procedure.)** Wait for the unit to light.
10. Set the Rinnai Infinity to 'Forced Low' combustion by setting No. 7 dipswitch to 'ON'. (Fig. 3)

off	on	SW
		1
		2
		3
		4
		5
		6
		7
		8

Fig. 3

*** Note:**

Simply changing the position of the dip switches will not convert the unit from one gas type to the other. The conversion procedure requires a change of injector manifold. Contact Rinnai or your supplier.

GAS PRESSURE SETTING

11. Check the burner test point operating pressure.

12. Remove rubber access plug and adjust the regulator screw on the modulating valve (Fig. 4) as required to the pressure below. Replace rubber access plug.

N.G	G20	1.8 mbar
	G25	1.8 mbar
LPG	G30	2.2 mbar
	G31	2.2 mbar

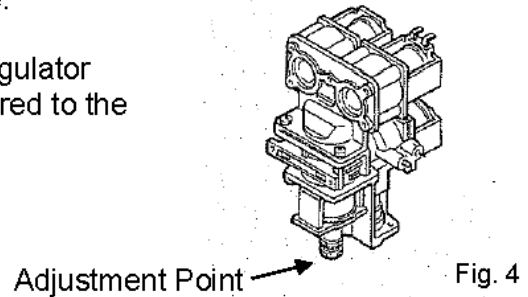

13. Set the Rinnai Infinity to 'Forced High' combustion by setting no. 7 and no. 8 dipswitches to 'ON'. (Fig.5) Ensure maximum water flow.

14. Check the burner test point pressure.

15. Adjust the high pressure potentiometer on the Printed Circuit Board above SW1 (Fig. 6) to the pressure shown below. The potentiometer is very sensitive, turn no more than a few degrees at a time; then let the pressure settle down before turning it more.

N.G	G20	9.0 mbar
	G25	9.0 mbar
LPG	G30	14.2 mbar
	G31	14.2 mbar

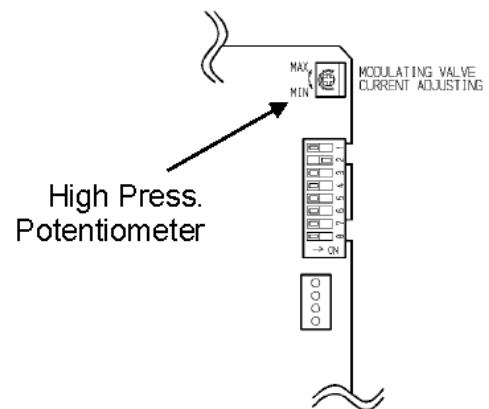
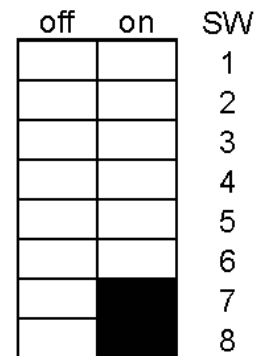

16. **IMPORTANT:** Set dip switch no. 7 and no. 8 to 'OFF' to return the appliance to 'Normal' combustion.

17. Close hot water tap.

18. Turn OFF the gas supply and 230V power supply.

19. Remove pressure gauge, and replace sealing screw.

20. Turn 'ON' the gas supply and 230V power supply.

21. Operate unit and check for gas leaks at test point.

22. Replace the front cover of the appliance.



DIP SWITCH SETTING

Dip Switch Positions Explained

OFF	ON	SW	
<input type="checkbox"/>	<input type="checkbox"/>	1	- Gas Type
<input type="checkbox"/>	<input type="checkbox"/>	2	- Gas Type
<input type="checkbox"/>	<input type="checkbox"/>	3	- Computer Programming
<input type="checkbox"/>	<input type="checkbox"/>	4	- Computer Programming
<input type="checkbox"/>	<input type="checkbox"/>	5	- Computer Programming
<input type="checkbox"/>	<input type="checkbox"/>	6	- Max. Temperature
<input type="checkbox"/>	<input type="checkbox"/>	7	- Combustion
<input type="checkbox"/>	<input type="checkbox"/>	8	- Combustion

LEGEND:
Black Section indicates position of dip switch.

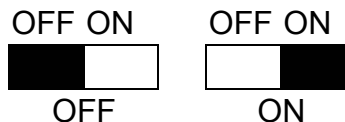

Dip Switches Explained

GAS TYPE

LPG

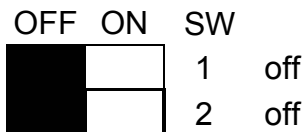

NAT GAS

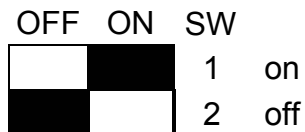

COMBUSTION

NORMAL

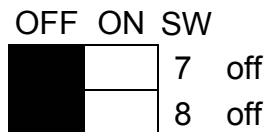

FORCED LOW

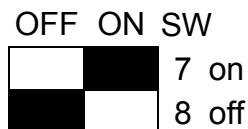

COMPUTER PROGRAMMING

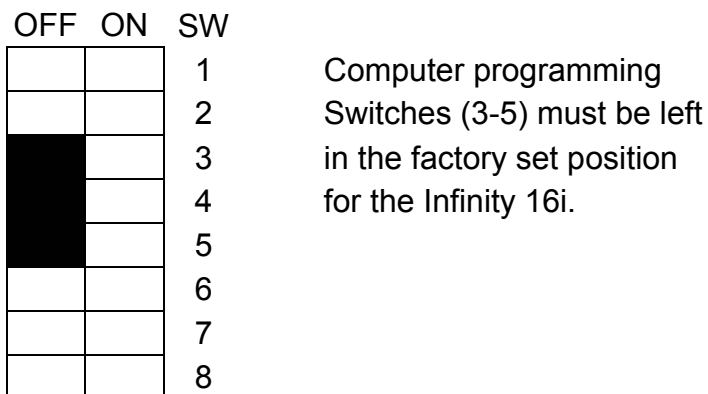

FORCED HIGH

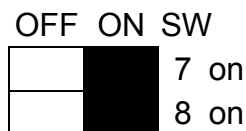

MAXIMUM TEMPERATURE

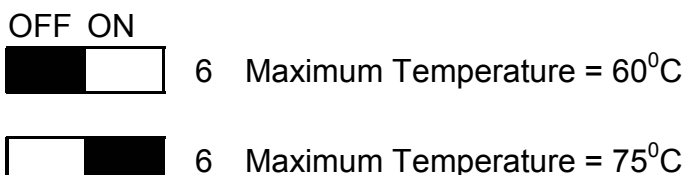

DIMENSIONS

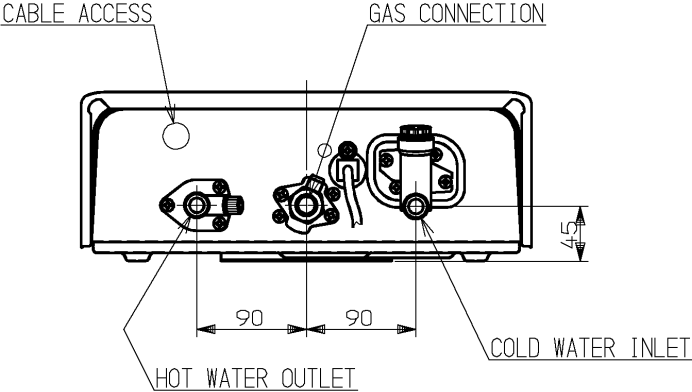
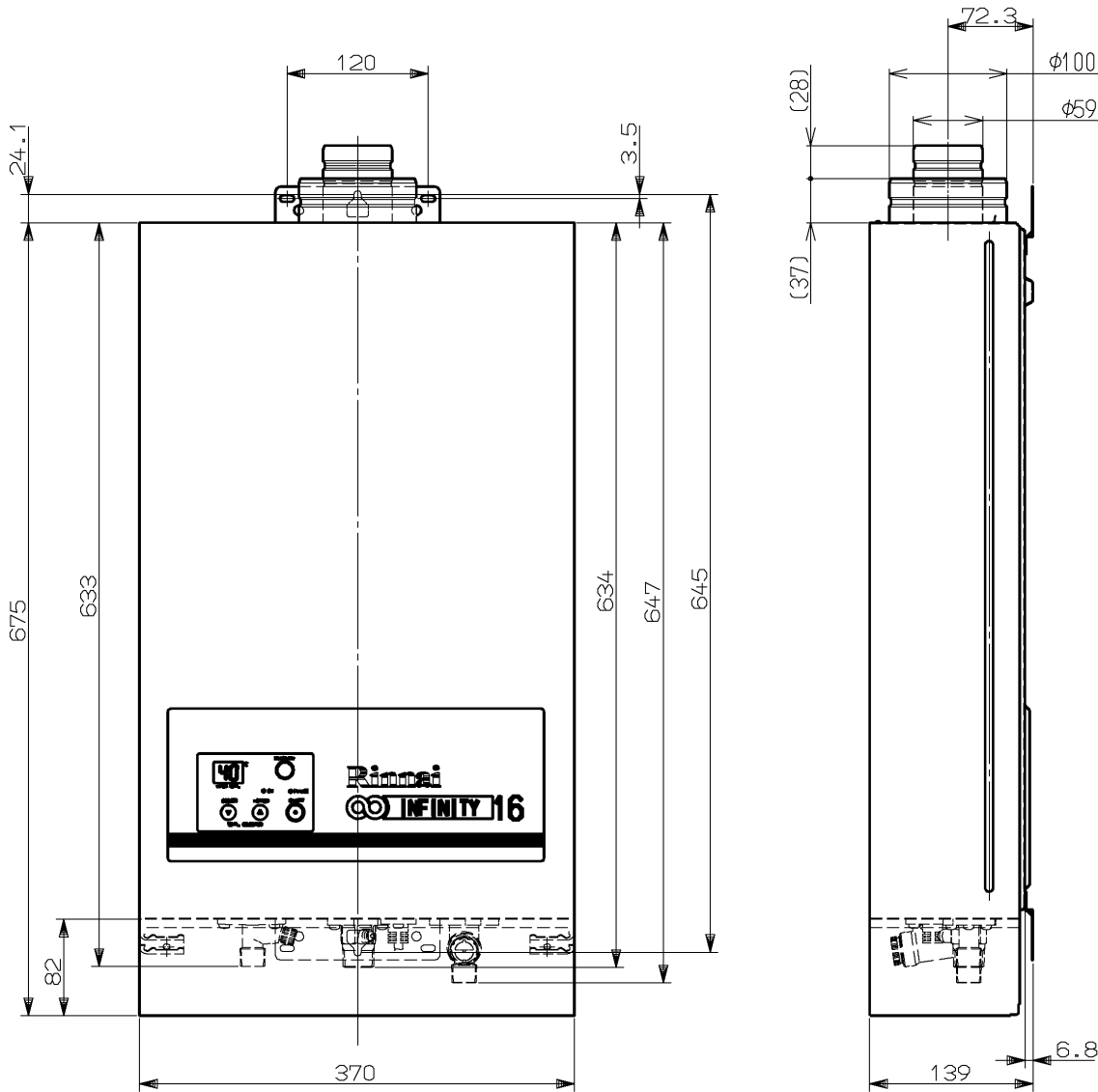

TECHNICAL DETAILS

Infinity Model	Infinity 16i		Units	
Installation	Internal			
G20 Nat Gas Press Low	1.8	mbar		
G20 Nat Gas Press High	9.0	mbar		
G25 Nat Gas Press Low	1.8	mbar		
G25 Nat Gas Press High	9.0	mbar		
G30 LPG (Butane) Press Low	2.2	mbar		
G30 LPG (Butane) Press High	11.4	mbar		
G31 LPG (Propane) Press Low	2.2	mbar		
G31 LPG (Propane) Press High	14.2	mbar		
Height	675	mm		
Width	370	mm		
Depth	130	mm		
Weight	15	kg		
Flue System	Concentric Forced Draught			
Temp. Range Controllers	35 - 60	deg C		
Max Temp. via dip switch	75	deg C		
Ignition	Direct Electronic Ignition			
Gas Consumption Low (Gross)				
G20 Nat Gas	4.7	kW	0.4	m ³ /hr
G25 Nat Gas	4.0	kW	0.4	m ³ /hr
G30 LPG (Butane)	4.9	kW	.35	kg/hr
G31 LPG (Propane)	4.9	kW	.35	kg/hr
Gas Consumption High (Gross)				
G20 Nat Gas	34.9	kW	3.26	m ³ /hr
G25 Nat Gas	29.6	kW	3.26	m ³ /hr
G30 LPG (Butane)	36.8	kW	2.6	kg/hr
G31 LPG (Propane)	36.5	kW	2.6	kg/hr
Max Flow raised 25C	15.2	L/min		
Min Operation Flow	2.4*	L/min		
Water Pressure Nom.	1.1 - 7.0	bar		
Power Supply	230 V / 50 Hz			
Electric Consumption	68	Watts		

* Minimum operation flow based on temperature setpoint and inlet conditions.

FLOW CHART

OPERATION

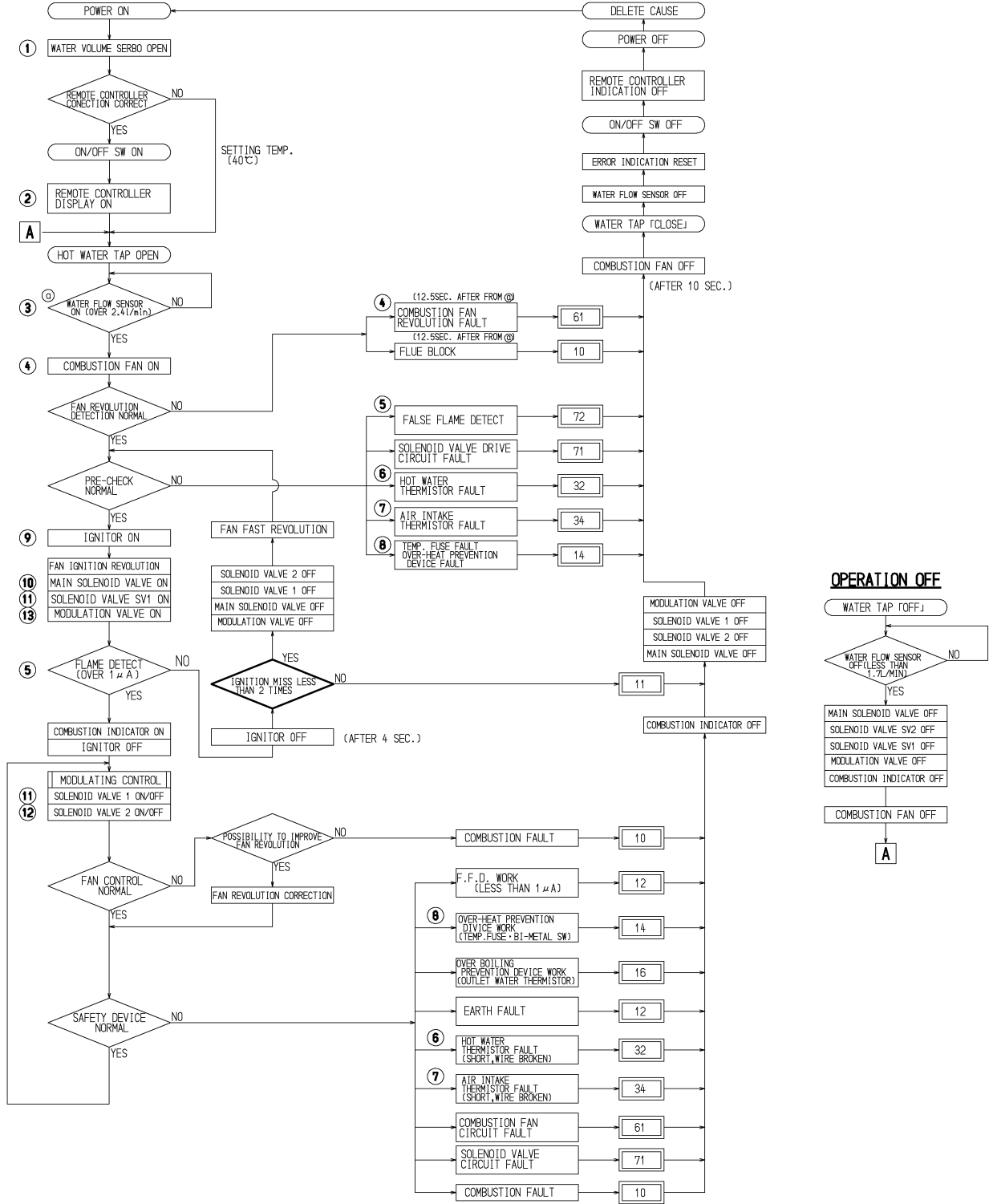

WIRING DIAGRAM

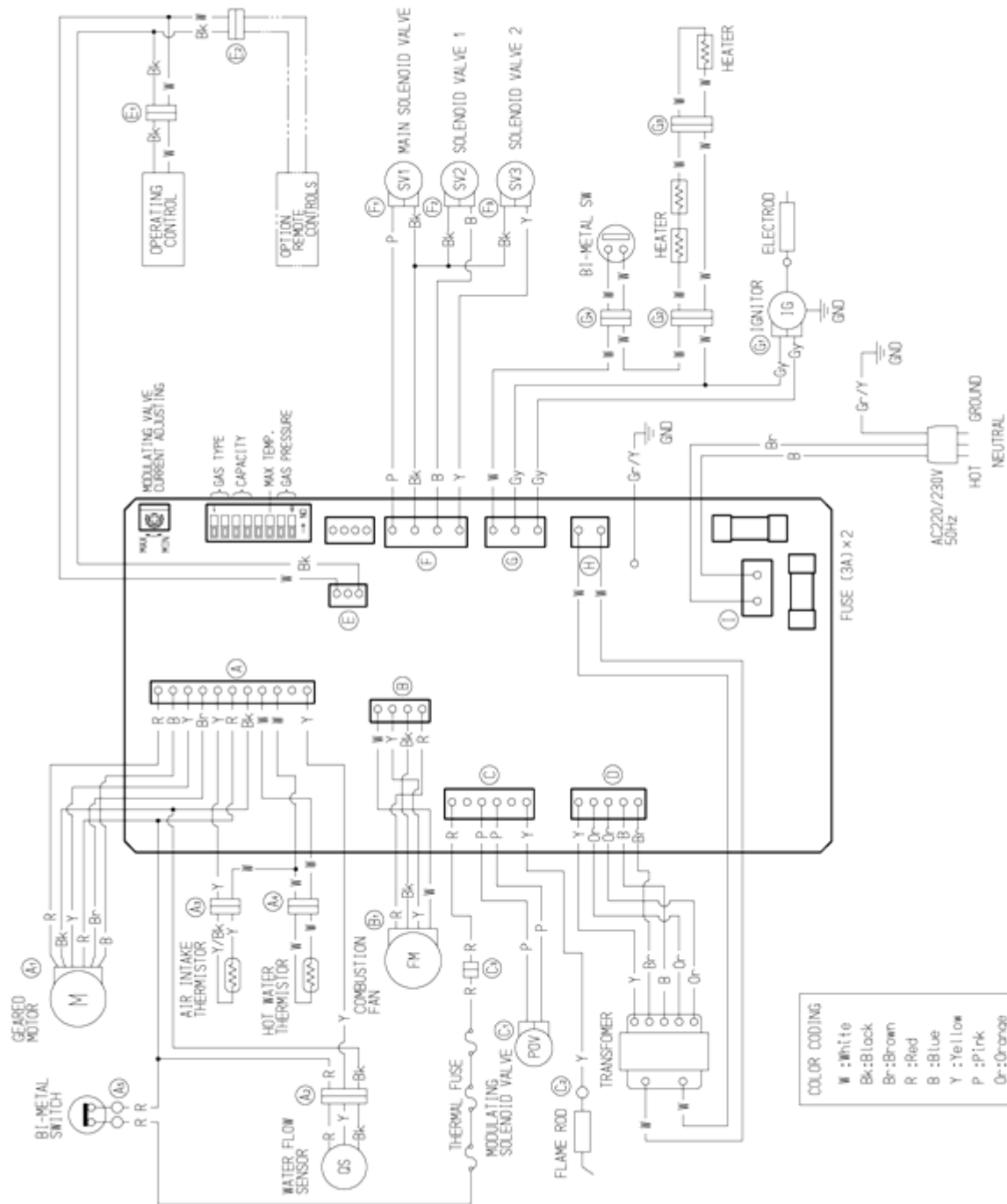

DIAGNOSTIC POINTS

Flow Chart No.	Component	Measurement point		Determination (normal figure) Upper : Voltage Lower : Resistance, Current	Remark
		CN	Wire Color		
		I	B-Br	AC200~AC240V	AC power
①	GEARED MORTOR	A ₁	R-B	DC11~13V 10~30Ω	Drive power
			R-Bk	DC11~13V	Control power
			Y-Bk	Below DC1V(limiter ON) Below DC4~6V(limiter OFF)	Full open limiter
			Br-Bk	Below DC1V(limiter ON) Below DC4~6V(limiter OFF)	Full close limiter
②	REMOTE CONTROLS	E ₁	Bk-W	DC11~13V	
③	WATER FLOW SENSOR	A ₂	R-Bk	DC11~13V	ON2.4L/min (35Hz) over 2100 pulse/min. OFF1.7L/min (24Hz) below 1440 pulse/min
			Y-Bk	DC4~7V(pulse 17~400Hz)	
④	FAN MOTOR	B ₁	R-Bk	DC6~40V	More than 1200 pulse/min
			Y-Bk	DC11~13V	
			W-Bk	DC2~10V(pulse 20~400Hz)	
⑤	FLAME ROD	C ₂	Y-earth	More than DC1 μA	At ignition
⑥	HOT WATER THERMISTOR	A ₄	W-W	15 °C...11.4~14.0kΩ 30 °C... 6.4~ 7.8kΩ 45 °C... 3.6~ 4.5kΩ 60 °C... 2.2~ 2.7kΩ 105°C... 0.6~ 0.8kΩ	Measure Thermistor side (small wire)
⑦	AIR INTAKE THERMISTOR	A ₃	Y/Bk-Y	15 °C...20.1~17.9kΩ 30 °C...10.2~ 8.9kΩ 45 °C... 5.5~ 4.7kΩ 60 °C... 3.1~ 2.6kΩ 105°C... 0.7~ 0.5kΩ	Measure Thermistor side (small wire)
⑧	THERMAL FUSE	C ₃ A ₅	R-switch	Less than 1Ω	
⑨	IGNITOR	G ₁	Gy-Gy	AC200~240V	
⑩	MAIN SOLENOID VALVE	F ₁	P-Bk	DC200~240V 6.0~7.8KΩ	
⑪	SOLENOID VALVE 1	F ₂	B-Bk	DC200~240V 7.8~10.8KΩ	
⑫	SOLENOID VALVE 2	F ₃	Y-Bk	DC200~240V 7.8~10.8KΩ	
⑬	MODULATING VALVE	C ₁	P-P	DC2~15V 67~83Ω	

TRANSFORMER VOLTAGES AND RESISTANCES

Connector	Wire Color	Normal Value
H	W-W	AC200~240V 11~20Ω
D	Or-Or	AC49~55V 1.3~1.7Ω
D	B-Br	AC12~14V 0.7~1.3Ω
D	Br-Y	AC195~216V 175~215Ω

LETTER OF COMPLIANCE

Rinnai
CORPORATION

GAS AND HOME
APPLIANCES

2-26, FUKUZUMI
NAKAGAWA, NAGOYA
JAPAN 454-0802
TELEPHONE : +81(0)52-361-8257
FACSIMILE : +81(0)52-361-8871
<http://www.globalrinnai.com>

Declaration of conformity

We, Rinnai Corporation, Nagoya herewith confirm that the REU-16FUA-E is in accordance with the following directives

Directive:

90/396/EEC Gas directive
73/23/EEC Low Voltage directive
89/336/EEC EMC directive

Nagoya, 20th December 2005
Rinnai Corporation



Yuzo Yoshida
Director, General Manager

CE CERTIFICATE

TECHNIGAS

Module B

EC TYPE EXAMINATION CERTIFICATE

Annex II Paragraph I directive 90/396/EEC



Certificate number : E0940/5399 *Date of issue* : 23/12/2005
ID number : 0461BQ0836

Fabricant : RINNAI Corporation
Manufacture : Fukuzumi-Cho 2-26
Fabrikant : JP - Nakagawa, Nagoya

Marque commerc. : RINNAI
Trade mark
Handelsmerk

Type : REU-16FUA-E
Model
Type

Genre d'appareil : INSTANTANEOUS WATER HEATER
Kind of product
Soort toestel

Type d'appareil : C13/ C33
Appliance type
Type toestel

Countries of destination, appliance categories :

AT Cat: I2H/ I3B/P G20/20mbar/ G30/50mbar/ G31/50mbar
BE Cat: I2E(S)B/ I3P G20/20mbar/ G25/25mbar/ G31/37mbar
CY/ HU/ MT Cat: I3B/P G30/30mbar/ G31/30mbar
CZ/ DK/ EE/ FI/ GR/ IT/ LT/ LV/ NO/ SK/ SI/ SE Cat: I2H/ I3B/P G20/20mbar/ G30/30mbar/ G31/30mbar
DE/ LU Cat: I2E/ I3B/P G20/20mbar/ G30/50mbar/ G31/50mbar
FR Cat: I2Esi/ I3P G20/20mbar/ G25/25mbar/ G31/37mbar
IE/ PT/ ES/ CH/ GB Cat: I2H/ I3P G20/20mbar/ G31/37mbar
NL Cat: I2L/ I3B/P G25/25mbar/ G30/30mbar/ G31/30mbar
PL Cat: I2E/ I3B/P G20/20mbar/ G30/37mbar/ G31/37mbar

Normative references : EN 26 edition 01/1997
EN 26/A1 edition 10/2000

DIRECTOR
K DE WIT

TGP-08-14
2002-04-12

TECHNIGAS - Rodestraat, 125 - B-1630 Linkebeek
Phone +32.2.383 02 00 - Fax +32.2.380 87 04
e-mail : technigas@technigas.be - website : www.technigas.be

COMMISSIONING CHECK LIST

For full details - Refer to Installation Instructions

Attention Installer - have you checked:

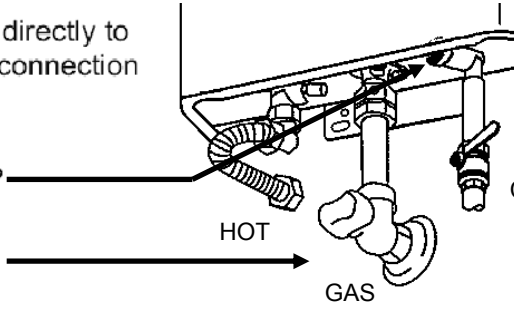
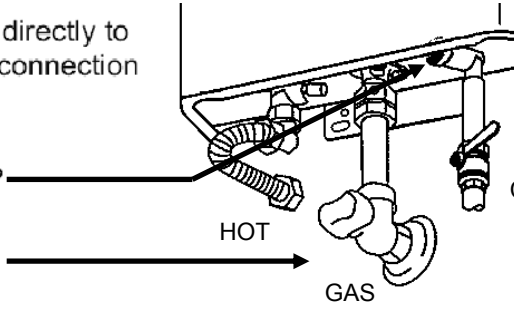
- Gas supply pipe is purged of foreign matter before connection.
- For Hot and Cold cross connections i.e. Capped breaches/shower mixers, taps closed and reversed 'Flick Mixer' connections?
- That isolating valves are not connected directly to the appliance and there is means of disconnection after the isolating valve?
- Have you cleaned cold water inlet filter? 
- That plumbing connections are correct? 
- Is appliance inlet gas pressure correct with all appliances operating?
- Do the Master Controllers (if fitted) operate correctly?
- Have you checked water temperature at all outlets?
- Have you shown the customer how to operate the Temperature Controllers? (If fitted)
- Have you explained to the customer the minimum flow rate required to operate the unit?
- Have you explained to the Customer the Benefits of Controllers (If not fitted) and that they can be added later?

UK WARRANTY

As the purchaser of this high quality Rinnai Water Heater you are provided with the following conditional warranty.

	Heat Exchanger		All Other Parts	
	Parts	Labour	Parts	Labour
	Standard Use	1 Year	1 Year	Year
16i				
Commercial Use	1 Year	1 Year	1 Year	1 Year
16i				

Rinnai Infinity units used in Commercial Situations are only subject to a 1 year warranty across the board. Commercial situations should be supplied by the Rinnai HD range.

No Rinnai warranty will cover damage/ faults arising from moving or storing the unit; improper installation or gas supply; water contaminants beyond defined limits; environmental factors; plumbing fittings, or other outside influences of which Rinnai is not responsible. Service calls for these issues will be chargeable. The unit must be serviced annually to validate the warranty.

The warranty period begins on customer's date of purchase.

Description	pH	Total Dissolved Solids (TDS)	Total Hardness	Chlorides	Magnesium	Calcium	Sodium	Iron
Maximum Recommended Levels	6.5 - 9.0	600 mg/litre	150 mg/litre	300 mg/litre	10 mg/litre	20 mg/litre	150 mg/litre	1 mg/litre

SPECIFICATION

Model	Infinity 16i
Installation	Internal location only
Fuel	Natural Gas or LPG *
Control	Modulating
Output (nominal)	4 kW to 30 kW
Exhaust type	Forced Draught Flue
Ignition	Electronic
Burner	Stainless steel
Weight	15kg
Water flow rate	2.4** to 20 L/min
Minimum operating water pressure	1.0 Bar
<u>Connections</u>	
Gas	1/2BSP
Water Inlet	1/2BSP
Water outlet	1/2BSP
Electrical Supply	230V AC 50Hz 1ph

* Separate models available for Natural gas or LPG fuel.

** Minimum flow rate based on temperature setpoint and inlet conditions.

Rinnai are continually updating and improving products and reserve the right to alter model specifications without prior notice.

CONTACT

Rinnai UK LTD.

9 Christleton Court

Manor Park

Runcorn

Cheshire

WA7 1ST

Tel. 01928 531870

Fax. 01928 531880

E-mail. info@rinnaiuk.com

Web. www.rinnaiuk.com